



INOFlex[®] VT-S

4-Backen-Kraftspannfutter mit Durchgang
4-jaw through hole power chuck

ANWENDUNG

- Spannen von runden, quadratischen/rechteckigen und geometrisch unregelmäßigen Bauteilen
- Für verformungsempfindliche Bauteile geeignet
- Hohl- und Teilhohlspannung möglich
- Innen- und Außenspannung

TECHNISCHE MERKMALE

- Zentrisches ausgleichendes Spannen
- Spannhubkontrolle

APPLICATION

- Clamping of round, square/rectangular and irregular parts
- For deformation sensitive parts
- For open center or partial open center clamping
- Internal and external clamping

TECHNICAL FEATURES

- Compensating concentric clamping
- Clamping stroke control

Technische Daten technical information		VT-S 013	VT-S 016	VT-S 021	VT-S 026	VT-S 031	VT-S 040	VT-S 050	VT-S 063	VT-S 080
Ident-Nr. / ident-no.		845113	845116	845121	845126	845131	845140	845150	845163	845180
Durchmesser / diameter	mm	135	168	218	264	315	400	500	630	800
Durchgang through-hole	mm	32	46	52	72	91	111	142	165	165
Hub pro Backe radial jaw stroke	mm	2,7	3,4	4,3	5	5,5	6,2	6,2	6,2	6,2
Ausgleichshub compensation	mm	1,8	2,3	3,3	4	4,4	5	4,5	4,5	4,5
Kolbenhub axial piston stroke	mm	12	15	19	22	24	27	27	27	27
max. Betätigungskraft max. draw pull	kN	15	20	40	55	60	85	90	90	90
max. Spannkraft max. gripping force	kN	37,5	50	100	125	150	210	230	230	230
max. Drehzahl max. speed	1/min r.p.m.	5500	5000	3900	3500	3000	2100	1400	1100	900
Masse (ohne Backen) weight (without top jaws)	kg	6,5	12	26	42	64	119	207	315	498
Massenträgheitsmoment moment of inertia	kg · m ²	0,05	0,05	0,19	0,42	0,89	2,69	7,4	17,2	41
Nutenstein / standard t-nut	—	—	GP05	GP07	GP11	GP11	GP13	GP21	GP21	GP21
Standard weiche Aufsatzbacke standard soft jaw	—	—	VS11	VS12	VS17	VS17	VS21	VS25	VS25	VS25
Standard harte Aufsatzbacke standard hard jaw	—	—	VG10	VG12	VG17	VG16	VG21	VG25	VG25	VG25

INOFlex® VT-S

Spannkraft-/Drehzahl-Diagramm
Clamping force - speed diagram

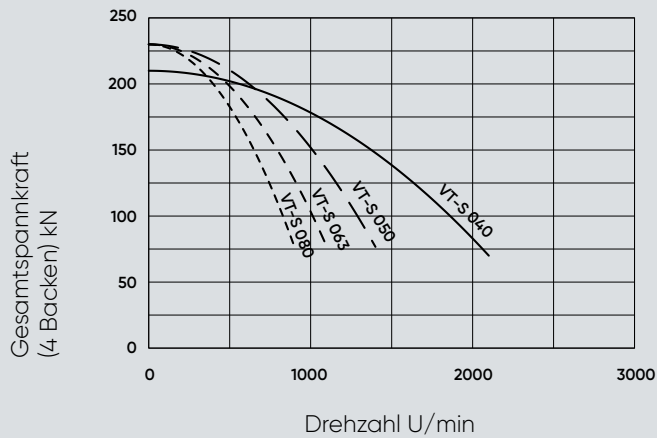
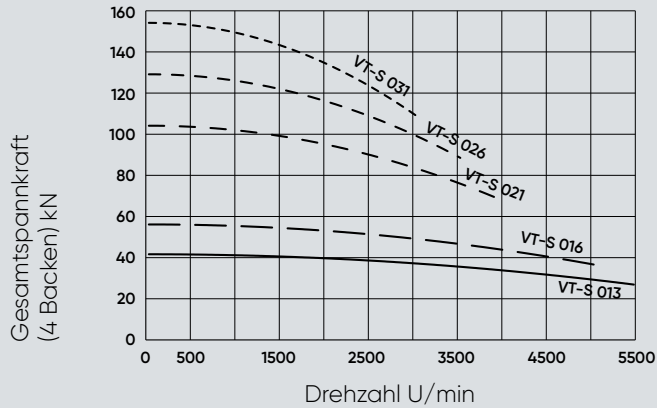

Beim Einsatz der weichen Standardbacke bündig außen aufgebaut.
When using the soft standard jaw mounted even with the outer diameter of the chuck.

* statische Nutmutter
* fixed ring-nut

VT-S 013

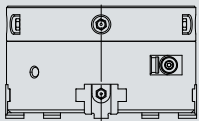
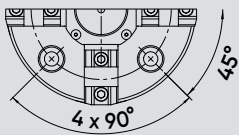

VT-S 016 - VT-S 040

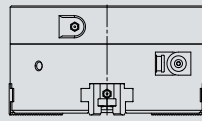
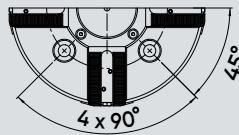

VT-S 050

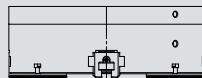
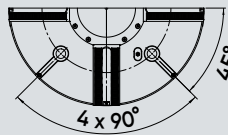

VT-S 063

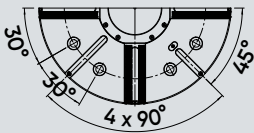

VT-S 080

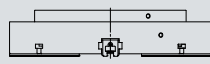
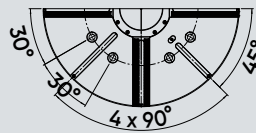

	VT-S 031	VT-S 040	VT-S 050	VT-S 063	VT-S 080
5	400	500	630	800	
5	400	500	600	600	
0	380	380	520	520	
5	330,2	330,2	463,6	463,6	
	111	142	165	165	
2	142	167	193	193	
00 x 2	M125 x 2	M155 x 2	M180 x 2	M180 x 2	
	30	30	30	30	
4	154	164,5	164,5	164,5	
	6	8	8	8	
/ 40	29,6 / 56,6	30 / 57	30 / 57	30 / 57	
5	117	147	192	276	
	52	58	58	58	
	5	10	10	10	
x 60°	1,5 x 60°	3,0 x 60°	3,0 x 60°	3,0 x 60°	
	3,5	6	6	6	
5	11,5	16,5	16,5	16,5	
0	202,2	249,3	314,3	399,3	
	26	24,5	24,5	24,5	
	26	30	25,5	25,5	
	30	60	60	60	
/ 73	40 / 103	70 / 121	70 / 158	70 / 242	
	21	25	25	25	
	21	25	25	25	
2 x 30	M16 x 35	M20 x 55	M20 x 55	M20 x 55	
	—	14	22	22	
	—	23	40	40	
	—	25	38	38	
	—	9	16	16	
	—	66	170	245	
	—	66	110	185	



INOFlex® VT-S



IN
4-E
4-j

ANWENDUNG

- Spannen von runden, quadratischen/rechteckig-geometrisch unregelmäßigen Bauteilen
- Für verformungsempfindliche Bauteile geeignet
- Hohl- und Teilhohlspeisung möglich
- Innen- und Außenspannung

TECHNISCHE MERKMALE

- Zentrisches ausgleichendes Spannen
- Spannhubkontrolle

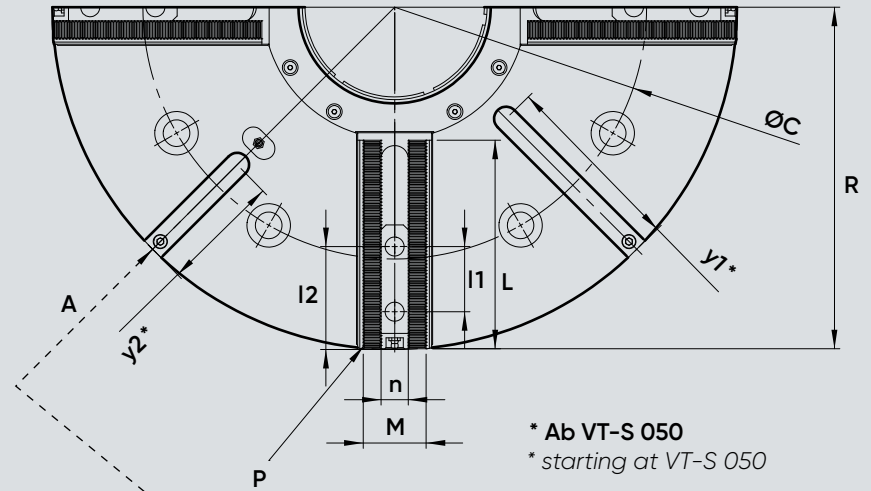

* Ab VT-S 050
* starting at VT-S 050

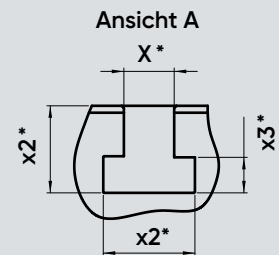

Technische Daten <i>technical information</i>	VT-S 013	
Ident-Nr. / ident-no.	845113	
Durchmesser / diameter	mm	135
Durchgang through-hole	mm	32
Hub pro Backe radial jaw stroke	mm	2,7
Ausgleichshub compensation	mm	1,8
Kolbenhub axial piston stroke	mm	12
max. Betätigungskraft max. draw pull	kN	15
max. Spannkraft max. gripping force	kN	37,5
max. Drehzahl max. speed	1/min r.p.m.	5500
Masse (ohne Backen) weight (without top jaws)	kg	6,5
Massenträgheitsmoment moment of inertia	kg · m ²	0,05
Nutenstein / standard t-nut	—	—
Standard weiche Aufsatzbacke standard soft jaw	—	—
Standard harte Aufsatzbacke standard hard jaw	—	—

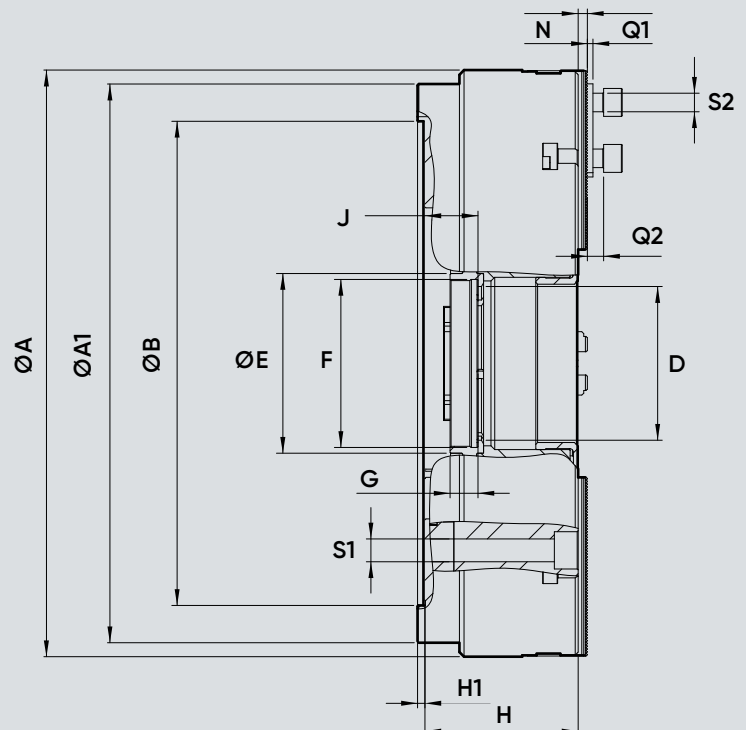



Schau dir das
VT-S-Spannfutter im Detail an!
Look at the VT-S-chuck in detail!

* statische Nutmutter
* fixed ring-nut

Abmessungen dimensions	VT-S 013	VT-S 016	VT-S 021	VT-S 026	VT-S 031	VT-S 040	VT-S 050	VT-S 063	VT-S 080	
A mm	135	168	218	264	315	400	500	630	800	
A1 mm	135	168	218	264	315	400	500	600	600	
B H6 mm	125	140	170	220	300	380	380	520	520	
C mm	100	104,8	133,4	171,4	235	330,2	330,2	463,6	463,6	
D mm	32	46	52	72	91	111	142	165	165	
E mm	—	—	67	92	112	142	167	193	193	
F mm	M40x1,5*	M56 x 1,5*	M60 x 2	M85 x 2	M100 x 2	M125 x 2	M155 x 2	M180 x 2	M180 x 2	
G mm	12	18	20	20	24	30	30	30	30	
H mm	72	88	109,2	125	134	154	164,5	164,5	164,5	
H1 mm	4	5	5	5	5	6	8	8	8	
min./max.	J mm	12 / 24	18 / 33	17 / 36	10 / 32	16 / 40	29,6 / 56,6	30 / 57	30 / 57	30 / 57
L mm	—	46,5	61,5	78	88,5	117	147	192	276	
M mm	24	32	34	42	46	52	58	58	58	
N mm	4	1,5	2	2	2	5	10	10	10	
Verzahnung / serration	P mm	14 KV	1,5 x 60°	1,5 x 60°	1,5 x 60°	1,5 x 60°	1,5 x 60°	3,0 x 60°	3,0 x 60°	3,0 x 60°
Q1 mm	3	2,5	3	3	3	3,5	6	6	6	
Q2 mm	7,5	10,5	11,5	11,5	11,5	11,5	16,5	16,5	16,5	
Futter geöffnet / chuck open	R mm	68	84,9	108,9	134,1	160	202,2	249,3	314,3	399,3
S1 mm	10,5	10,5	12,5	16,5	22	26	24,5	24,5	24,5	
T mm	12	12	17,2	26	22	26	30	25,5	25,5	
l1 mm	25	18	20	30	30	30	60	60	60	
min./max.	l2 mm	26,9 / 29,6	22 / 39,5	25 / 52	35 / 62	35 / 73	40 / 103	70 / 121	70 / 158	70 / 242
n H8 mm	10	10	12	16	16	21	25	25	25	
o H7 mm	14	10	12	16	16	21	25	25	25	
S2 mm	M6 x 16	M8 x 22	M10 x 25	M12 x 30	M12 x 30	M16 x 35	M20 x 55	M20 x 55	M20 x 55	
x H12 mm	—	—	—	—	—	—	14	22	22	
x1 mm	—	—	—	—	—	—	23	40	40	
x2 mm	—	—	—	—	—	—	25	38	38	
x3 mm	—	—	—	—	—	—	9	16	16	
y1 mm	—	—	—	—	—	—	66	170	245	
y2 mm	—	—	—	—	—	—	66	110	185	

